

TECHNICAL INFO **NINFEA**  
BY GIOVANNONI DESIGN





## Ninfea

Letto multifunzione 4 movimentazioni, per trattamenti viso, corpo e massaggi con regolazione elettrica di altezza per schienale e gambe.

Il materasso è rivestito in sky, ignifugo e resistente agli olii. La struttura metallica è rivestita in legno incurvato ed è dotato di cassettoni portaccessori.

*Multi-purpose bed with 4 movements for face, body treatments and massages with electrical backrest and leg rest height adjustment.*

*Mattress covered in oil- and fire-resistant eco-leather.*

*The metal frame is covered in curved wood and has an accessory holder drawer*



## Braccioli removibili

*Removable pillow*

I cuscini situati nella parte alta dello schienale sono estraibili. In occasione dei trattamenti che richiedono la posizione prona (massaggi, depilazione delle gambe, ecc.) essi possono essere rimossi; in questo modo il Cliente può restare confortevolmente disteso, appoggiando il volto e le braccia negli spazi lasciati liberi. I cuscini vengono facilmente tolti e inseriti manualmente. Ricordarsi di rimetterli nella loro sede alla fine del trattamento.

*The pillows in the top part of the backrest can be removed. For treatments requiring that the client lay face down (massages, leg depilation, etc.) they can be removed; in this way, the client will be more comfortable when lying, placing the face and arms in the holes left free. The pillows are easily removed and replaced by hand.*

*Remember to replace them in their seat after treatment.*





## Termocoperte/Heater blankets

Per garantire una piacevole esperienza durante i trattamenti, anche nei mesi più freddi, è utile il comfort termico della coperta elettrica.

Il lettino Omnia può essere dotato di termocoperte posizionate sotto il rivestimento esterno.

La temperatura rilasciata in maniera costante aiuta contro gli sbalzi termici che il corpo può avvertire durante i trattamenti e il calore aiuta l'effetto rilassante sulla muscolatura.

Il dispositivo è dotato di uno schermo touch con 8 livelli di temperatura.

La scelta di questo optional deve essere effettuata dal Cliente al momento dell'ordine.

*To ensure a pleasant experience during treatments, even in the colder months, the heater blanket offers thermal comfort.*

*The Omnia bed can be used with heater blankets positioned under the outer covering.*

*The constant temperature helps to reduce thermal shocks during treatments, and the heat helps to relax the muscles.*

*The device has a touch screen with 8 temperature levels.*

*The customer can select this optional item at the time of order.*

## Foro Viso/Face hole

Il lettino Ninfea è dotato di un cuscino estraibile situato nella parte alta dello schienale.

In occasione dei trattamenti che richiedono la posizione prona (massaggi, depilazione delle gambe, ecc..) il cuscino può essere rimosso e il Cliente può restare confortevolmente disteso, appoggiando nel foro.

Il cuscino viene facilmente tolto e inserito manualmente.

Ricordarsi di rimetterlo nella sua sede alla fine del trattamento.

*The Ninfea bed is equipped with a removable pillow in the top of the backrest.*

*For treatments requiring that the client lay face down (massages, leg depilation, etc.) the pillow can be removed and the client can lie comfortably, placing the face in the hole.*

*The pillow is easily removed and replaced by hand. Remember to replace in its seat after treatment.*

## Memory Foam

Il confortevole cuscino è di spessore 6,5 cm di schiuma multistrato a celle piccole e vi è incluso uno strato di memory foam.

*The comfortable pillow is in 6.5 cm thick small-cell multi-layer foam with a layer of memory foam.*

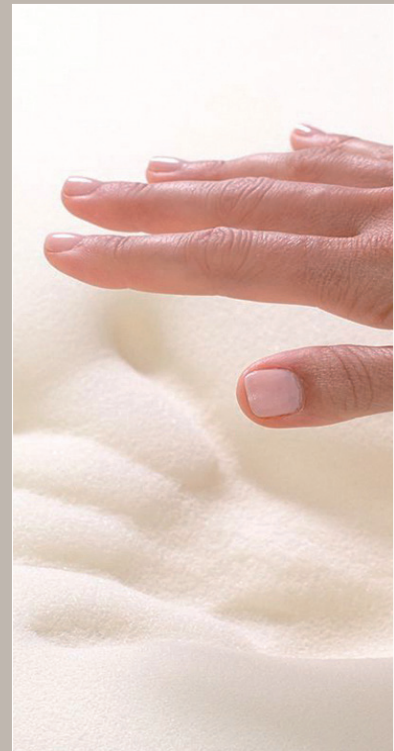

# NINFEA

BY GIOVANNONI DESIGN



Cod. NINFEA N9287  
Cod. NINFEA N9287T

## INFO TECNICHE/ TECHNICAL INFO

- Lettino multifunzione 4 movimentazioni, per trattamenti viso, corpo e massaggi.
- Materasso rivestito in skay, ignifugo e resistente agli olii
- Regolazione elettrica di altezza, schienale e gambe
- Braccioli abbattibili con pompa-gas.
- Struttura metallica rivestita in legno incurvato



- *Multi-purpose bed with 4 movements for face, body treatments and massages.*
- *Mattress is covered in oil- and fire-resistant eco-leather*
- *Electrical height, backrest and leg rest adjustment*
- *Folding arm rests with gas-pump.*
- *Metal frame covered in curved wood*

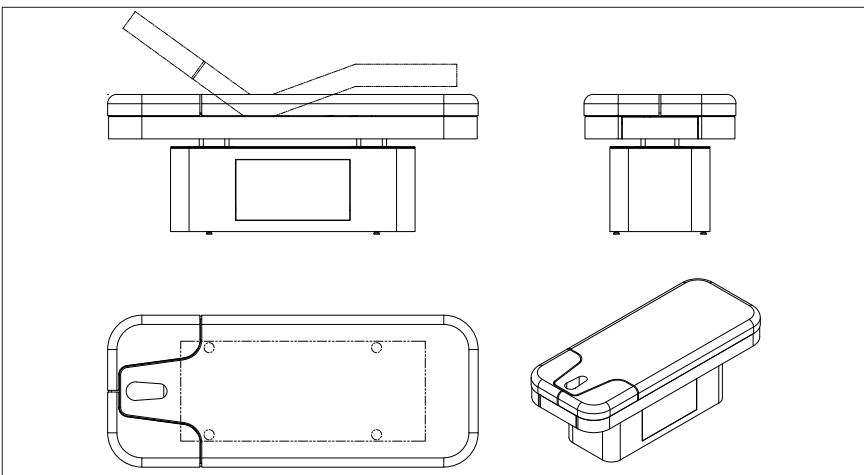

Telecomando/Remote control



Cassetto / Tray

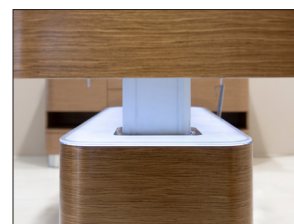

Led



Cusc. removibili / Removable cush.

Box / Packing	Peso / Net Weight	Volume / Volume
Box: 900X2180X877 mm	Kg 146	mc 2,024
Pallet: 930X2200 mm	Peso lordo imballo/ Gross weight packaging 186 kg	

Caratteristiche Tecniche / Technical Features
460 W (Termico / Thermal) 360 W (Non Termico / Non thermal) 230v +/- 10% - 50/60 Hz

Sede/Registered office:  
via Armani, 1A  
42019 Scandiano - Reggio Emilia, Italia  
Telefono: +39.0522.7631 - Fax: +39.0522.766676  
E-mail: info@nilo-beauty.com





# NINFEA

BY GIOVANNONI DESIGN

Cod. NINFEA N9287  
Cod. NINFEA N9287T

## OPTIONS



Riscaldamento/Heating system



Cuscino/Knee Roll



Memory-foam



Porta rotolo/Paper Holder

## LEGNI/WOOD FOR NINFEA



Rovere sbiancato/Bleached oak



Invecchiato/Aged

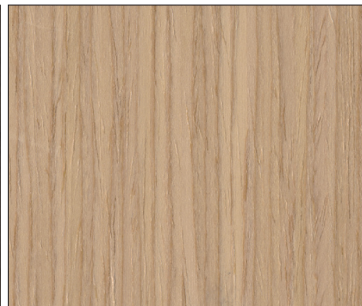

Rovere Chiaro/Light Oak

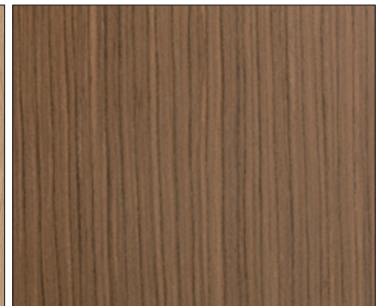

Noce/Walnut

## SKAY OPTION



828 Rosa Sarah Lavoine

PVC



810 Beige

PU



825 Light Beige

PU



826 Bright Beige

PU



805 Espresso

PU

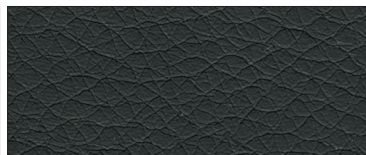

806 Black

PU

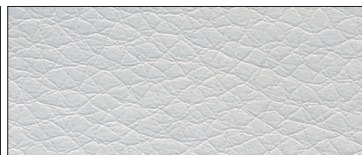

818 Pearl

PU

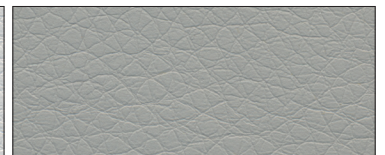

819 Light Grey

PU



574 Fango Vintage

PVC

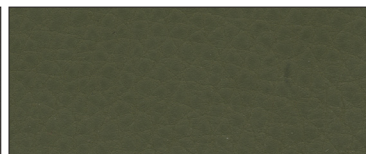

824 Dark Green

PVC

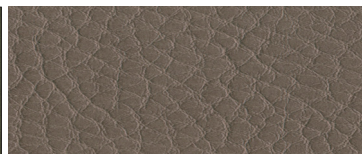

918 Visone

PVC



584 New cuoietto

PVC



827 Dark Brown

PVC

Sede/Registered office:  
via Armani, 1A  
42019 Scandiano - Reggio Emilia, Italia  
Telefono: +39.0522.7631 - Fax: +39.0522.766676  
E-mail: info@nilo-beauty.com



# NINFEA

BY GIOVANNONI DESIGN



Cod. NINFEA N9287  
Cod. NINFEA N9287T

## SKAY OPTIONS

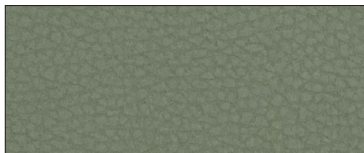

795 Salvia

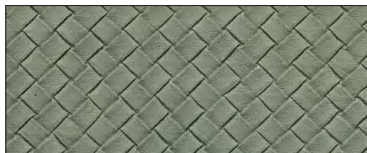

795 G 56 salvia W

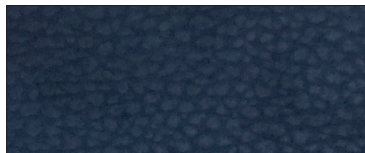

561 KE ocean blu

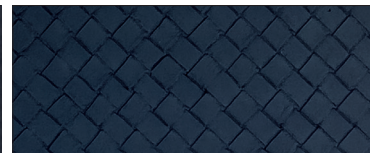

561 KE G 56 ocean blu W

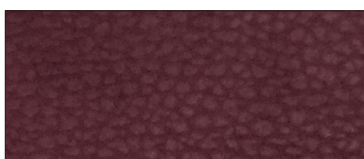

535 Bordo'

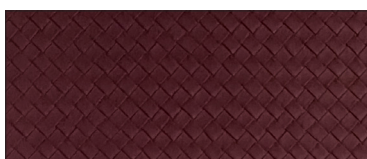

535 G 56 Bordo' W



PU 575 Cammel



575 G 56 Cammel W



828 G 56 Rosa W

## SCHEDA TECNICA TECHNICAL DATA SHEET

### Articolo / Article:

Peso / Weight	UNI EN ISO 2286 - 1:2001	Gr/m <sup>2</sup>	480	+/- 10
Spessore / Thickness	UNI 4818-2	mm	1,00	+/- 0,10
Composizione / Composition		%	COT 19,5 - PES 26,3 - PU 54,2	
Altezza Rotoli / Width		Cm	138 +/-2	
Resistenza a Trazione / Tensile Strength	UNI EN ISO 1421:2000	N/5 cm	Ordito / Along ≥500 Trama / Across ≥350	
Resistenza alla Lacerazione / Tear Strength	UNI EN ISO 4674 - 1:2005	N	Ordito / Along ≥30 Trama / Across ≥25	
Resistenza alla Cucitura / Seam Resistance	UNI 10606	N/cm	Ordito / Along 17,7 Trama / Across 40,6	
Allungamento Rottura / Ultimate Elongation	UNI EN ISO 1421:2000	%	Ordito / Along ≥15 Trama / Across ≥20	
Delaminazione Supporto / Peel Adhesion	UNI EN ISO 2411:2001	N/5cm	Ordito / Along ≥30 Trama / Across ≥25	
Abrasiono / Wear (Martindale)	UNI EN ISO 20344:2011	Cicli / Cycles	51.200 Secco/Dry 25.600 Umido/Wet	
Flessione / Flexing Endurance	UNI 4818 -13	Cicli / Cycles	≥100.000	
Idrolisi / Hydrolysis Resistance Jungle test	ISO 1419C:1995(E)	7 giorni 70°C 95% UM	Inalterato dopo flessioni 50.000	
Solidità colore rivestimento allo Stregamento Coating color fastness to Rubbing	UNI EN ISO 105 - X 12	Scala dei grigi Grey scale	Secco / Dry ≥4	Bagnato / Wet ≥4
Resistenza colore / Color fastness Luce artificiale / Artificial Light	UNI EN ISO 105 - B02:01	Scale dei Blu / Blue scale	5 colori bianco e medi white & medium colours 7 colori scuri/dark colours	

### Infiammabilità / Flammability

Standard:	
- UNI 9175 / FA1 (1IM);	- AFNOR NF P 92-503 (M2)
- IMO FTP (FTP Code Annex 1 Part 8 (1996) Imo Res A. 652 (16) (1989));	
A richiesta / on demand:	
- BS5852:2006; CLAUSE 11 (CRIB 5)	- BS 7176 / EN 1021 PARTS 1 & 2 1994
- FMVSS 302 U.S.A. Motor Vehicle Safety	- CALIFORNIA 117, SECTION E

Il prodotto non sopporta trattamento con cloro / Do not treat with chlorine

Il prodotto può essere stirato al rovescio, ad una temperatura max di 110°C, meglio frazionando un pannello umido.  
The product can be ironed on the back at a max temperature of 110°C, better interposing a humid cloth.

TRA DIFFERENTI LOTTI DI PRODUZIONE, POTRANNO VERIFICARSI LIEVI OSCILLAZIONI DI TONALITA' DI COLORE E MANO, CHE COMUNQUE RIENTRANO NELLE CONSUETUDINI DI TOLLERANZA. SI CONSIGLIA PERTANTO DI NON MESCOLARE, IN FASE DI LAVORAZIONE, PEZZE APPARTENENTI A LOTTI DIVERSI.

AMONG THE DIFFERENT PRODUCTION LOTS, IT CAN HAPPEN THAT THERE ARE SLIGHT VARIATIONS OF COLOR TONALITY AND TOUCH, WHICH ARE IN ANY CASE WITHIN THE TOLERANCE STANDARDS. WE THEREFORE RECOMMEND NOT TO MIX, DURING PRODUCTION, ROLLS BELONGING TO DIFFERENT LOTS.

Sede/Registered office:  
via Armani, 1A  
42019 Scandiano - Reggio Emilia, Italia  
Telefono: +39.0522.76631 - Fax: +39.0522.766676  
E-mail: info@nilo-beauty.com





# NINFEA

BY GIOVANNONI DESIGN

Cod. NINFEA N9287  
Cod. NINFEA N9287T

DISEGNO TECNICO/TECHNICAL DRAWING

